

THE ROLE OF SOIL AND INTERFACE NONLINEARITIES ON THE SEISMIC RESPONSE OF CAISSON SUPPORTED BRIDGE PIERS

Athanasios ZAFEIRAKOS¹, Nikos GEROLYMOS², George GAZETAS³

ABSTRACT

The present paper examines the seismic performance of caisson foundations under a new design philosophy, where soil "failure" is allowed to protect the superstructure. To investigate the effectiveness of such an approach, a caisson–column supported bridge structure is used as an example. Two alternatives are compared: one complying with conventional capacity design, with *over-designed* foundation so that the soil is marginally plastified; the other following the new design philosophy, with *under-designed* foundation, "inviting" the plastic "hinge" into the soil (Anastasopoulos et al. 2010). The two alternatives are then subjected to an artificial accelerogram appropriately calibrated so that both systems would exhibit the same spectral response in a linear elastic regime, allowing thus the seismic performance of the two systems to be achieved on a "fair" basis. Key performance measures of the systems are then compared, such as: accelerations, spectral response, displacements, pier base rotations and settlements. It is shown that separation of the caisson from the supporting soil and extensive soil plastification contribute beneficially to the seismic performance of both the foundation and the superstructure.

Keywords: Caisson foundations; Dynamic soil-structure interaction; Soil capacity mobilization; Seismic performance measures

INTRODUCTION

Caisson foundations deeply embedded in soft soil have been widely used to support major structures, especially bridges. Despite their large dimensions, caissons have been shown *not* to be immune to seismic loading as it was believed for many years, as was confirmed in the Kobe (1995).

Interestingly, although the lateral and seismic response of deep foundations has been of considerable interest for many years leading to the development of a number of methods of varying degrees of accuracy, efficiency and sophistication, only few of them are *devoted* to caissons. Instead, the methods of solution developed for (rigid) embedded foundation and for (flexible) piles have been frequently adopted.

This paper aims to shed some light in the seismic design of caisson foundations under the prism of performance based design, which in geotechnical earthquake engineering has, until recently, received little attention. More specifically, a *new seismic design philosophy* is applied, in which yielding of the soil–foundation system is "utilised" to *protect the superstructure*—exactly the opposite of conventional capacity design (in which plastic "hinging" is restricted to the superstructure, thus underestimating the

¹ MEng, National Technical University of Athens, e-mail: azafeirakos@yahoo.com.

² Lecturer, National Technical University of Athens, e-mail: gerolymos@gmail.com.

³ Professor, National Technical University of Athens, e-mail: gazetas@ath.forthnet.gr.

effect of soil and foundation). Fig. 1 schematically illustrates the difference between conventional design and the new concept, providing the basic idea of plastic “hinging” in the superstructure and the foundation respectively.

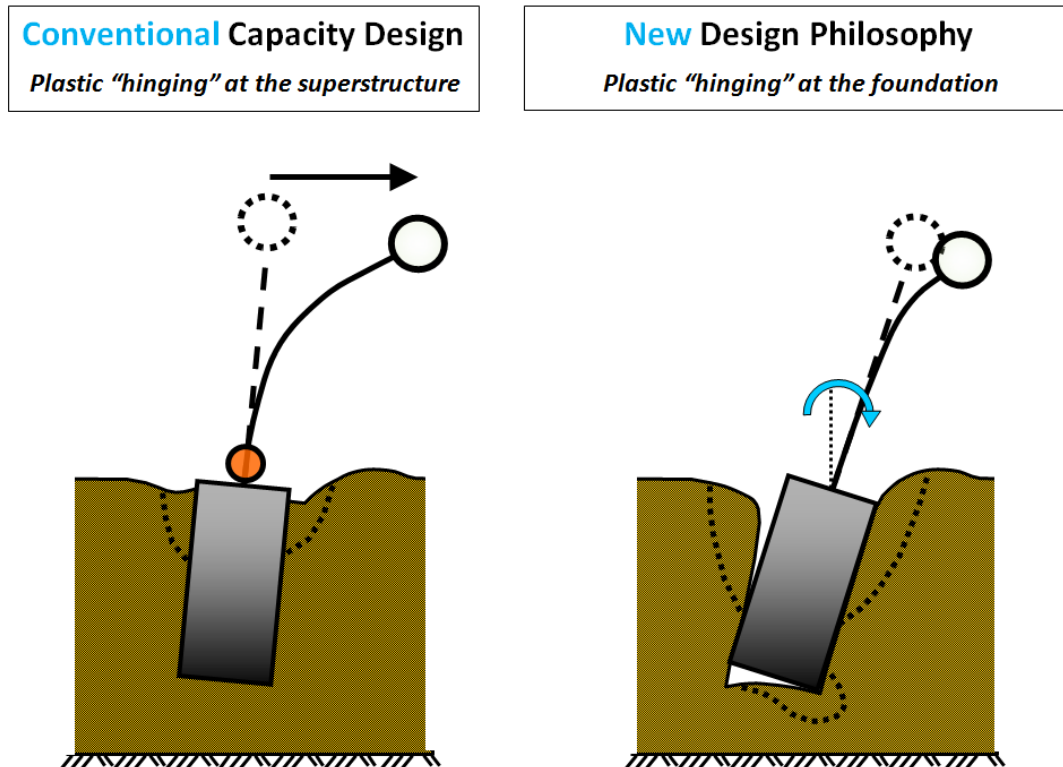

Fig. 1 Conventional capacity design (plastic “hinging” in the superstructure) compared with the new design philosophy (plastic “hinging” below ground)

To unravel the effectiveness of the new design philosophy (compared to conventional capacity design), a simple but realistic bridge structure founded on caisson foundation is used as an example. Two configurations are analysed and compared: (a) the first comprises a 8 m pier founded on a rigid cubic caisson, and (b) the second consists of a 33 m pier founded on a similar caisson, corresponding to a conventionally and an *un*-conventionally designed system respectively. Both systems are subjected to an artificial acceleration time history imposed at the base. This artificial seismic excitation is appropriately calibrated in a way that the spectral acceleration of a 1-DOF oscillator placed at the surface remains constant for a wide range of frequencies, practically unaffected by the dynamic characteristics of the soil-structure system (e.g. effective fundamental period). The analysis methodology will be explained thoroughly in the sequel.

Evidently, it is shown that allowing plastic hinging at the foundation restricts the loading transmitted onto the superstructure, but without avoiding the increase of earthquake-induced foundation settlements and rotations. Overall, however, the new design approach provides substantially larger safety margins.

It should be noted at this point that the results presented herein can be seen as a first demonstration of the potential advantages of the new concept. To become applicable in practice, the new design philosophy will have to be extensively verified analytically and experimentally (shaking table and centrifuge testing),

something which is the scope of the EU-funded project "DARE" (*Soil-Foundation-Structure Systems Beyond Conventional Seismic "Failure" Thresholds*).

PROBLEM DEFINITION AND ANALYSIS METHODOLOGY

Problem definition and model description

The studied problem is portrayed in Fig. 2: A bridge pier is founded through a rigid cubic caisson of side $h = 10$ m in a 20 m thick 2-layer cohesive soil stratum. The soils are saturated with $S_u = 65$ kPa at the upper 6 m and $S_u = 130$ kPa at the lower 14 m. The two alternative design approaches, conventional and un-conventional, are represented by two different column heights. In both cases the concentrated mass of the deck, M , is 2700 Mg, corresponds to a static factor of safety in both systems $FS_V = 5$. The design spectral acceleration is chosen $S_a = 0.6$ g.

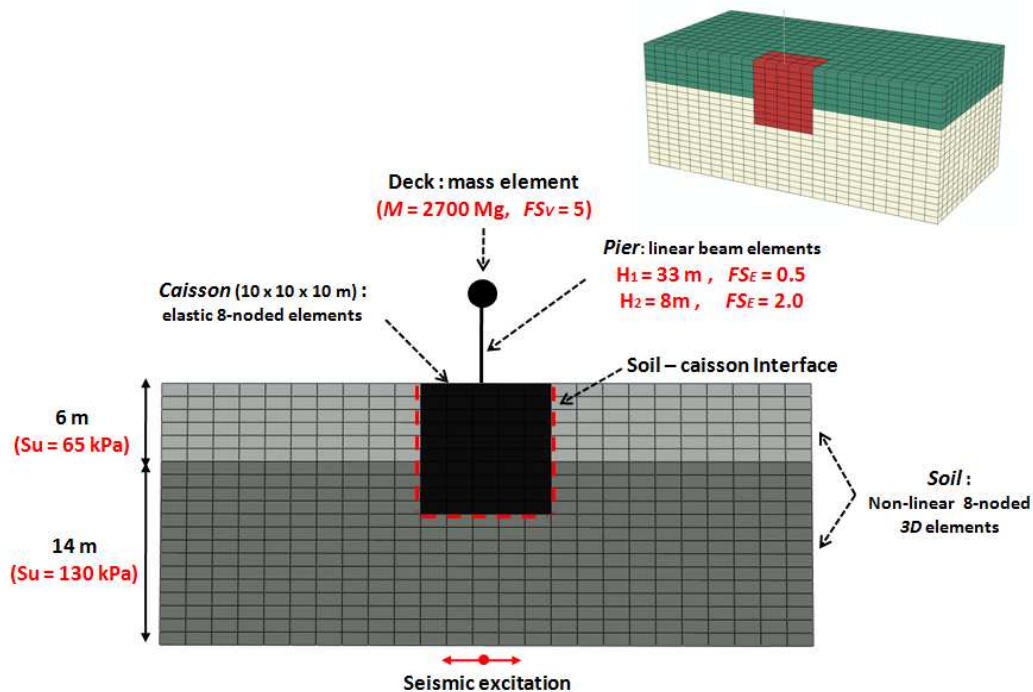

Fig. 2 Overview of the finite element modeling: plane-strain conditions are assumed, taking account of soil inelasticity and soil–caisson interface.

The problem is analysed with the use of the advanced Finite Element code ABAQUS. Both caisson and soil are modeled with 3-D elements, elastic for the former and nonlinear for the latter. The mass-and-column superstructures are modeled as single degree of freedom oscillators. The caisson is connected to the soil with special contact surfaces, allowing for realistic simulation of possible detachment and sliding at the soil-caisson interfaces. To achieve a reasonable stable time increment without jeopardizing the accuracy of the analysis, we modified the default hard contact pressure-overclosure relationship with a suitable exponential relationship. The soil stratum reaches 10 m deeper than the caisson base, thus having a negligible influence on the response. To ensure uniform stress distribution at the head of the caisson, the nodes of the associated elements are properly kinematically constrained. Inelastic soil behaviour is described through the Von–Mises yield surface with nonlinear kinematic hardening and an associative

plastic flow rule. The model of ABAQUS is calibrated using the methodology proposed by Gerolymos et al. (2005), Gerolymos (2006). Rayleigh damping, representing material damping, is taken equal to 5% between the eigenfrequency of the soil deposit and the dominant frequency of the earthquake ground motion. Appropriate kinematic constraints are imposed to the lateral edges of the model, allowing it to move as the free field (Giannakou et al. 2010).

The column heights associated with the two alternative design approaches, are calculated as illustrated in Fig. 3:

- For a specific vertical force at the head of the caisson, the moment (M)–horizontal load (Q) interaction diagram is produced, corresponding to the failure envelope (in M – Q space). Since $M = Q \cdot H$, the interaction between M and Q may also be interpreted as the lever arm height above the pier base (H) that leads to failure for a given Q . Furthermore, each point on the failure envelope corresponds to a safety factor for seismic loading $FS_E = 1.0$. In Fig.3 the results are presented normalized with respect to the pure moment capacity M_u (with no horizontal loading) and the pure horizontal capacity Q_u (with no moment loading) of the caisson–soil system.
- Given the mass of deck, $M = 2700 \text{ Mg}$, and the design spectral acceleration, $Sa = 0.6 \text{ g}$, the pseudo-static pier base shear force, $Q = M \cdot Sa$, is calculated, leading, in our case, to a ratio of $Q / Q_u = 0.4$.
- Having calculated Q / Q_u , the respective moment, M , at failure is extracted, $M / M_u = 0.65$, resulting further in a pier height $H = 16 \text{ m}$ (for a $FS_E = 1.0$).
- Given the pier height for $FS_E = 1.0$, a shorter pier, $H = 8 \text{ m}$, is designed in compliance with conventional capacity design, resulting from a $FS_E = 2.0$ and a taller pier, $H = 33 \text{ m}$, is considered in the spirit of the new philosophy, designed with a $FS_E = 0.5$ (lower than 1.0 – under-designed pier). In fact, as it will be shown below, the *under-designed* system will not allow the design seismic action to develop. Hence, FS_E does not really have a physical meaning in this case; it is just an *apparent* temporary factor of safety.

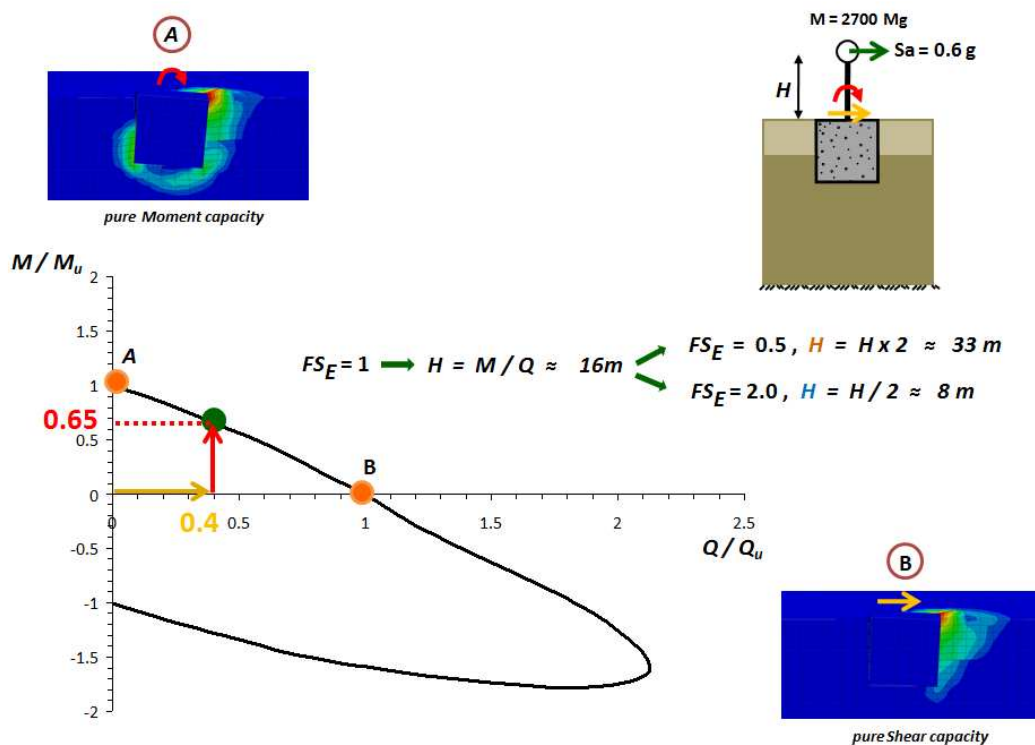

Fig. 3 Failure envelope of the soil–caisson configuration and calculation process of the alternatives' column heights.

The pier is modeled with 3-D linear elastic beam elements having properties of concrete. The cross-section of the pier is calculated so that the elastic (fixed-base) vibration period $T_{st} = 0.6$ sec, for both cases, deliberately larger than the first natural period, $T = 0.41$ sec, of the soil profile used in the analysis. In this way spurious oscillations at the boundaries of the model are limited as a result of a destructive interference (existence of a cut-off period for radiation damping equal to the first natural period of the soil profile) of the outward spreading waves (Gerolymos and Gazetas 2006, Gerolymos et al. 2008). This results in a solid cylindrical section with a diameter of $d = 3$ m for the conventionally designed pier ($H = 8$ m) and a hollow section of $d = 8.5$ m and thickness $t = 1.5$ m for the un-conventionally designed pier ($H = 33$ m). Fig. 4 illustrates the geometric configuration of both systems.

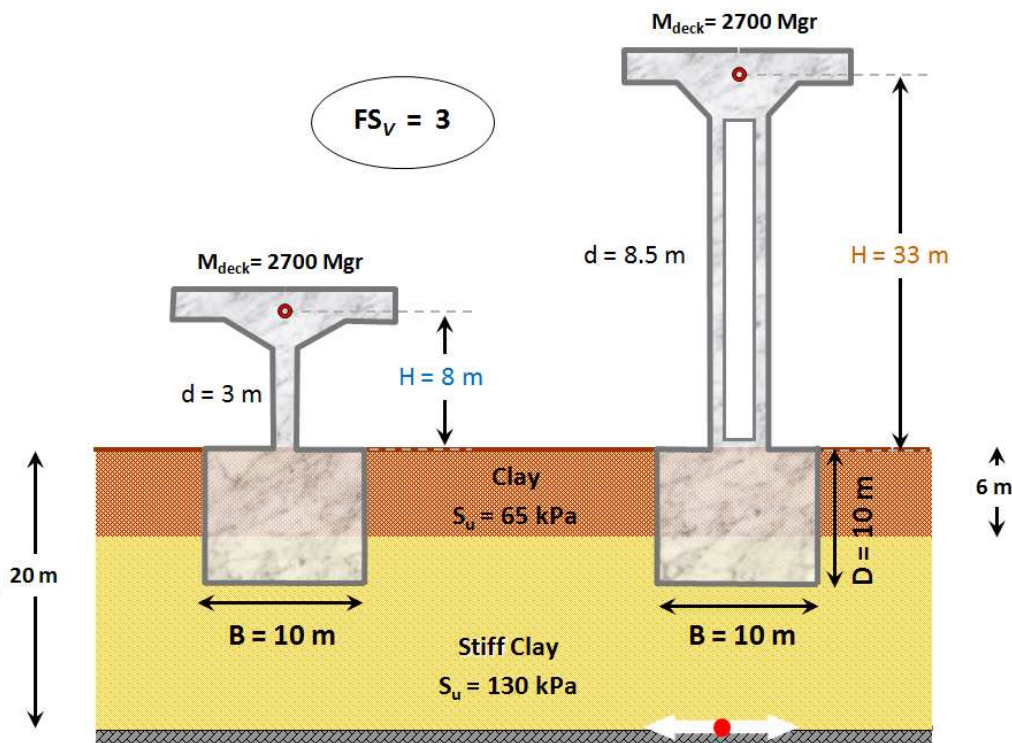

Fig. 4 Schematic illustration of the conventional and *un*-conventional system.

Methodology

The seismic performance of the two alternatives is investigated through nonlinear time-history analysis. It should be highlighted that in most published earthquake response analyses the examined systems are subjected to a variety of seismic motions to capture the interplay between the exciting dynamic characteristics (e.g. dominant periods, frequency content, PGAs, sequence of pulses) and the vibrational characteristics (natural, T_{st} , and effective fundamental period, T_s) of the structures. This paper, however, follows a methodology in which both systems are subjected to an appropriately calibrated seismic motion, so that their effective fundamental periods T_s fall within a plateau of constant spectral accelerations, thus eliminating the aforementioned interactions. Having, in this way, removed any bias of the response mechanisms on the dynamic properties, we may focus on the main question posed in this study, whether plastic mobilization of soil is beneficial or detrimental, and compare the two alternatives on a "fair" basis. The procedure, also schematically illustrated in Fig. 5, consists of the following steps:

- 1) A real accelerogram (also denoted as "natural" record) is selected as seismic excitation for both systems. In this paper the one recorded at Sakarya during 1999 Turkey earthquake is used. (Fig. 5a).
- 2) The "natural" record is then used as base excitation in a one-dimensional wave propagation analysis of the 2-layer soil profile and the free-field (top of soil profile) acceleration time-history (Fig. 5c) along with the respective response spectrum are derived. This spectrum is then compared with an artificial *target response spectrum* (Fig. 5d), which, in our case, resembles a typical code design spectrum, having a plateau in $S_a = 0.6 \text{ g}$ for a wide range of periods (0.2 to 1.6 sec; it will be shown that the effective periods T_s of both over and *under-designed* systems fall into this specific range).
- 3) Within a heuristic optimization procedure (trial and error technique), the base excitation is back-calculated by deconvoluting the calculated free-field motion, until the response spectrum matches the *target*. Upon matching, the new modified motion is used as the base seismic motion for the 3-D analyses of both systems (Fig.5b).

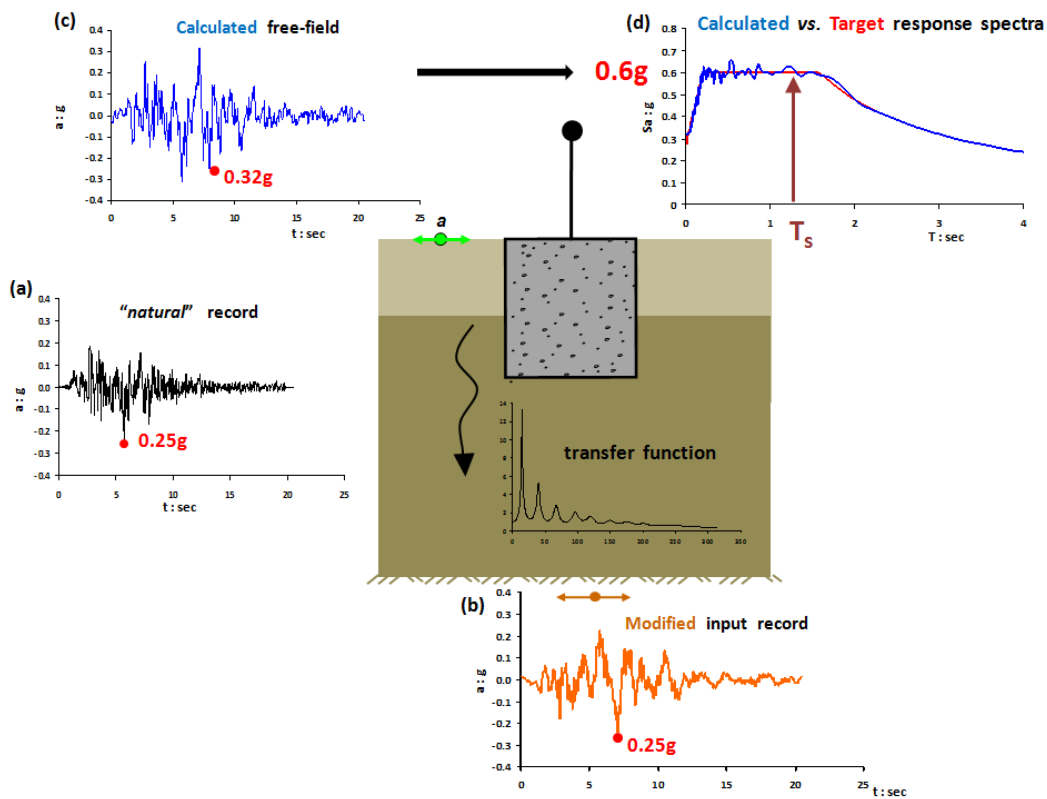

Fig. 5 Schematic illustration of the methodology for calculating the artificial accelerogram used in the dynamic analysis of both alternatives.

The process remains independent of the selected "natural" accelerogram.

ANALYSIS : RESULTS AND DISCUSSION

The comparison of the performance of the two design alternatives subjected to the artificial accelerogram is presented in Figs. 6–9, in terms of acceleration and displacement time–histories, deck "floor" response spectra, pier base moment–rotation and settlement–rotation.

The acceleration time–histories calculated at the deck are presented in Fig. 6a. Even though both systems were subjected to a design spectral acceleration of $S_a = 0.6$ g (Fig. 6c), the response of the *under-designed* ($H = 33$ m) system is significantly smaller, reaching a maximum of $a = 0.3$ g, in accord with the design seismic factor of safety $FSE = 0.5$, than for the *over-designed* ($H = 8$ m, $FS_E = 2.0$) where the full seismic action is developed ($a = 0.6$ g). This is the first evidence that mobilization of soil capacity hinders the development of the design seismic action, which is further demonstrated in the substantial decrease in the "floor" spectral accelerations at the mass of the superstructure (i.e., the spectral accelerations of the computed motion of the superstructure mass) in the *under-designed* case, as depicted in Fig. 6b.

The effective periods due to soil–structure–interaction effects, T_s , of the alternatives were derived from the free oscillations at the end of each shaking, resulting in $T_s = 0.8$ sec for the *over-designed* and $T_s = 1.5$ sec for the *under-designed* system (Fig. 6a), both falling within the range of the target spectrum plateau, $S_a = 0.6$ g. The main prerequisite for the validity of our methodology is thus met.

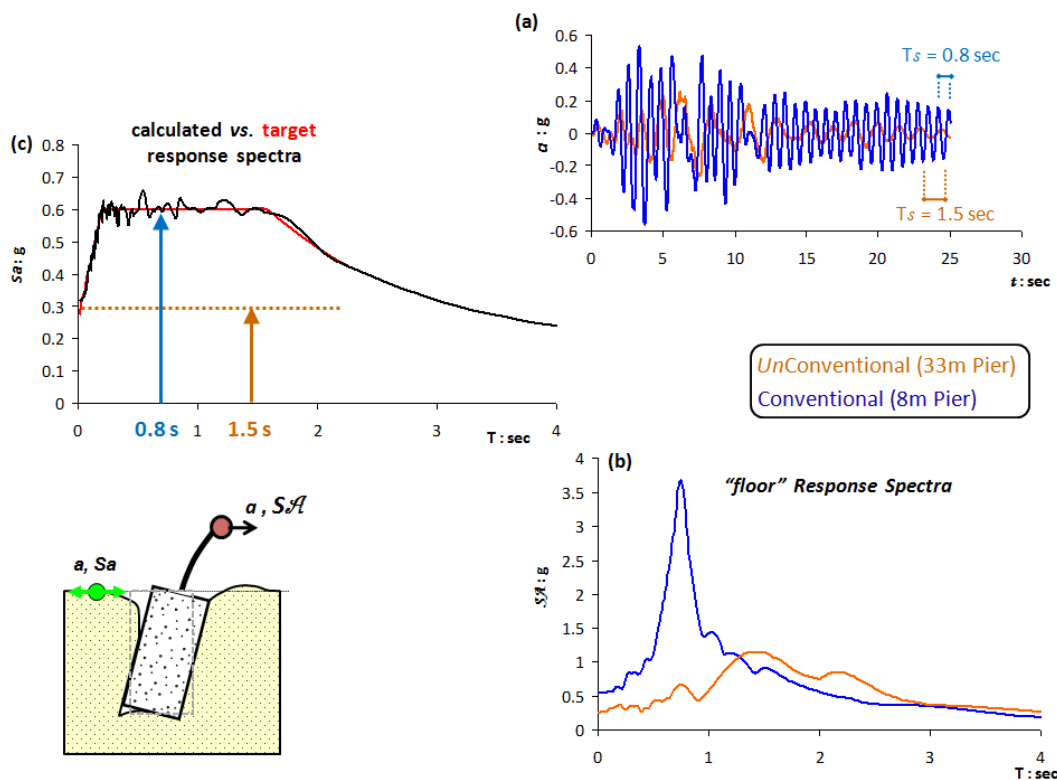

Fig. 6 Comparison of the response of the two alternatives subjected to the artificial accelerogram. (a) Acceleration time–histories at the deck mass, with the respective effective periods T_s . (b) Response spectra of the motion of the mass. (c) Computed free-field and target response spectra used for the dynamic analyses.

The time histories of deck horizontal displacement, i.e. the *drift*, for the two alternatives are compared in Fig. 7. As graphically illustrated in the adjacent sketch notation, the *drift* has two components (see also

Priestley et al. 1996): (i) the "rigid drift" $U_{rigid} = \theta H$, i.e. the displacement due to motion of the caisson as a rigid body, and (ii) the "flexural drift", i.e. the structural displacement due to flexural distortion of the pier column. Both U_{rigid} and U_{flex} are presented normalized with the respective maximum total displacement, U_{total_max} . This way, the contribution of pier flexural distortion and caisson rotation to the final result of interest (i.e. the total drift) can be inferred. As might have been expected, for the conventional design (*over-designed foundation*) the drift is mainly due to pier distortion U_{flex} , and thus increased structural distress. Exactly the opposite is observed for the *under-designed* foundation of the new design philosophy: the *drift* is mainly due to foundation rotation U_{rigid} , causing less seismic loading on the pier but increased total displacements due to soil yielding. Nevertheless, the total residual displacement for the new concept might be slightly larger, but quite tolerable: $U_{residual} \approx 5$ cm (compared to ≈ 0.5 cm for the conventional). In a nutshell, choosing to design a bridge pier *unconventionally* could substantially reduce the cost but would also demand appropriate provisions to accommodate for the increased seismic displacements.

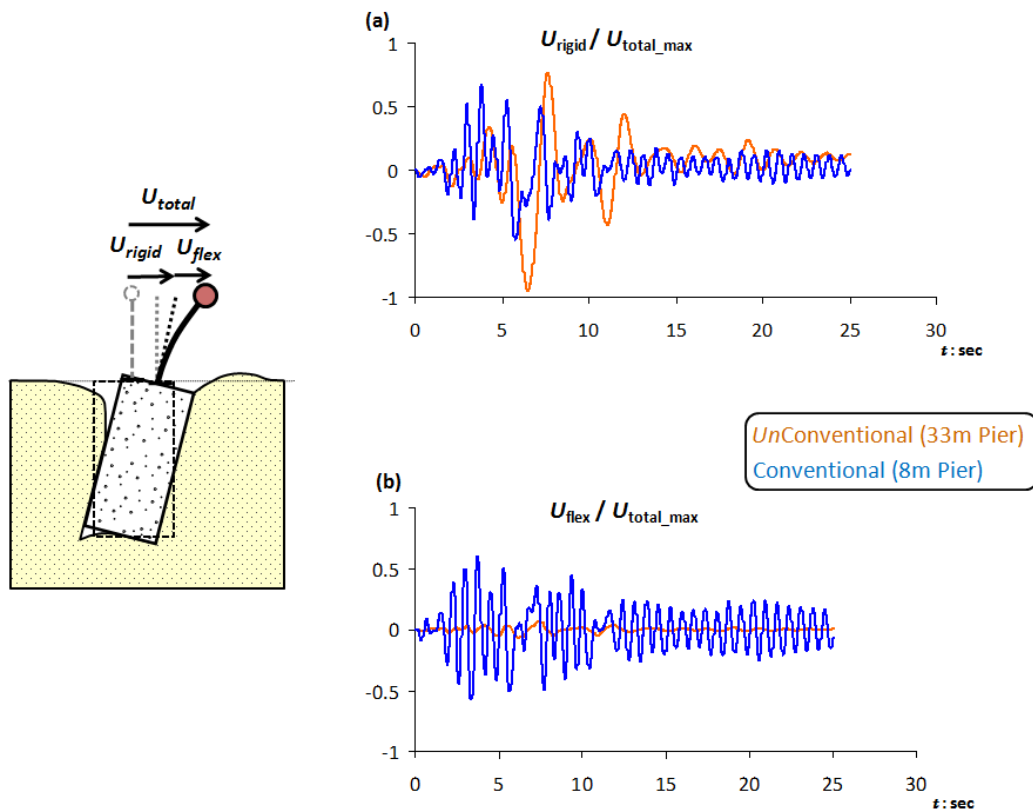

Fig. 7 Comparison of the response of the two alternatives. (a) Time-histories of the "rigid-body" drifts normalized with the respective maximum total drift. (b) Time-histories of the flexural drifts normalized with the respective maximum total drift.

In Fig. 8a the comparison is portrayed in terms of the foundation experienced moment-rotation ($M-\theta$). As expected, while the conventionally designed foundation experiences limited inelasticity (Fig. 8a2), the *under-designed* foundation (new design philosophy) behaves strongly inelastic (Fig. 8a1). Since both piers were modeled for elastic behavior, the main difference between the two alternatives lies in the mechanism of energy dissipation due to soil yielding. However, energy dissipation is not attainable at zero cost: in our case the cost is the increase of foundation settlement. Fig. 8b compares the settlement-

rotation ($w-\theta$) response for the two alternatives. The conventionally designed system is subjected to a practically elastic settlement $w \approx 3$ cm (Fig. 8b2). In marked contrast, the *under-designed* system of the new philosophy experiences larger but quite tolerable dynamic settlement: $w \approx 10$ cm (Fig. 8b1). Moreover, despite the excessive soil plastification, not only the structure does not collapse, but the residual (permanent) rotation is rather limited (as already attested by the residual deck drift), providing further evidence that mobilisation of soil capacity failure acts as a “*safety valve*” for the superstructure.

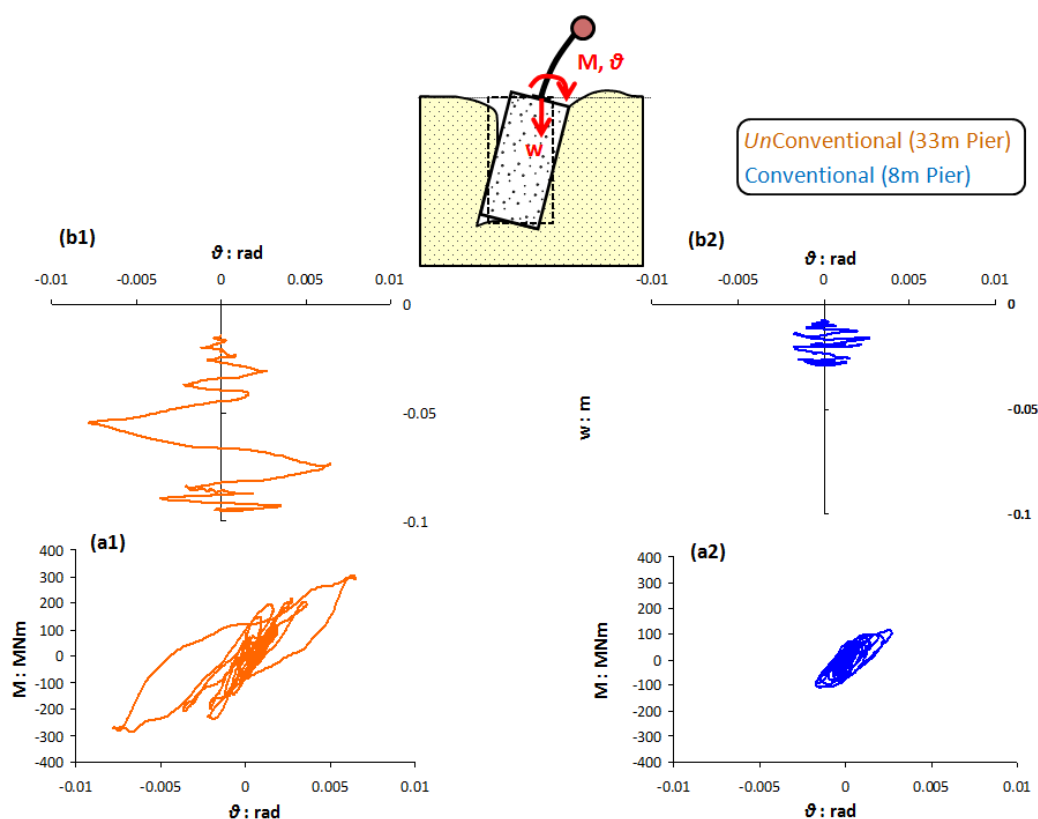

Fig. 8 Comparison of the response of the two alternatives. (a1), (a2) Overturning moment–rotation ($M-\theta$) response. (b1), (b2) Caisson settlement–rotation ($w-\theta$) response.

Fig. 9 compares the response of the two alternatives in terms of plastic shear strain contours at the end of the shaking. In the conventionally designed system (Fig. 9a) there is very little inelastic action in the soil, concentrated mainly at the top and bottom of the caisson. In contrast, the new design scheme (Fig. 9b) experiences rather extended “plastic hinging” in the form of mobilization of passive–type soil failure in front and back of the caisson accompanied by gap formation and sliding in the sides (deformation scale factor = 20).

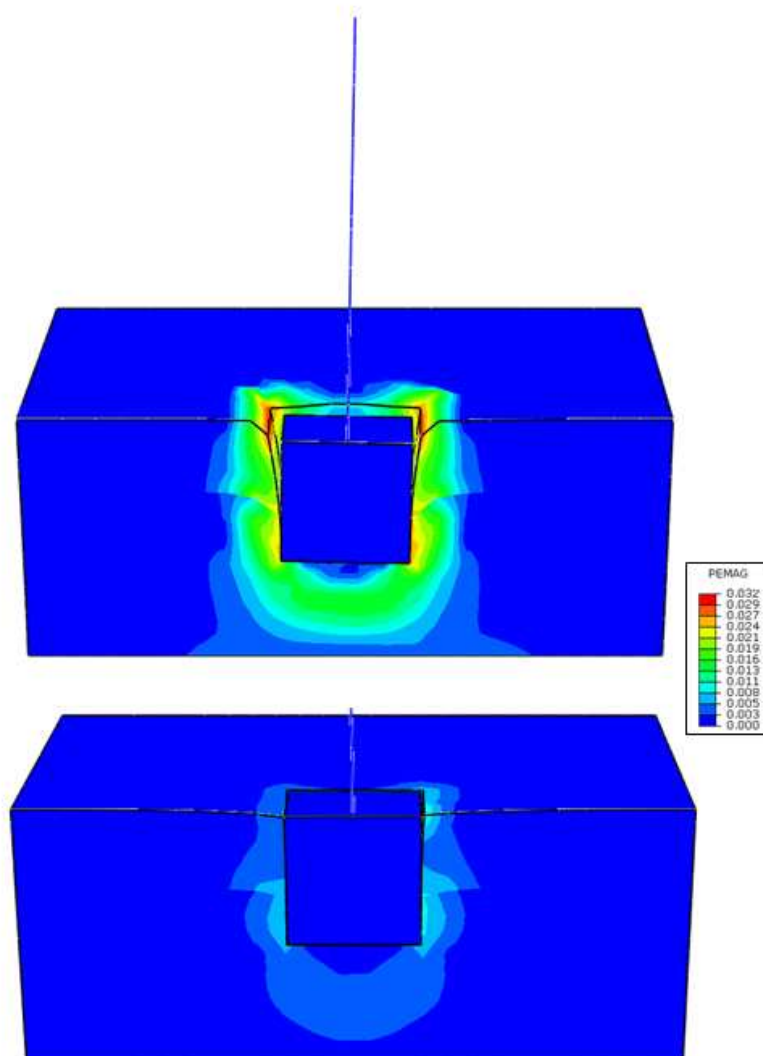

Fig. 9 Contours of plastic shear strain at the end of shaking for both alternatives (deformation scale factor = 20).

ACKNOWLEDGEMENTS

The authors would like to acknowledge financial support from the EU 7th Framework research project funded through the European Research Council's Programme "Ideas", Support for Frontier Research – Advanced Grant, under Contract number ERC-2008-AdG 228254-DARE.

REFERENCES

Anastasopoulos I, Gazetas G, Loli M, Apostolou M, Gerolymos N (2010) Soil failure can be used for seismic protection of structures. *Bull Earthq Eng* 6(4):705–722, pp. 309-326.

5th International Conference on Earthquake Geotechnical Engineering

January 2011, 10-13

Santiago, Chile

-
- Gerolymos N, Gazetas G (2006) Winkler model for lateral response of rigid caisson foundations in linear soil. *Soil Dyn Earthquake Eng* 26(5):347–361.
- Gerolymos N, Gazetas G (2006) Static and dynamic response of massive caisson foundations with soil and interface nonlinearities - Validation and results. *Soil Dyn Earthquake Eng* 26 (5), pp. 377-394.
- Gerolymos N, Gazetas G, Tazoh T (2005) Seismic response of yielding pile in non-linear soil. In: *Proc. 1st Greece–Japanworkshop*, seismic design, observation, and retrofit of foundations, Athens, 11–12 October, pp 25–36.
- Gerolymos N, Giannakou A, Anastasopoulos I, Gazetas G (2008) Evidence of beneficial role of inclined piles: observations and numerical results. *Bull Earthq Eng* 6(4):705–722 Special Issue: Integrated approach to fault rupture- and soil-foundation interaction.
- Giannakou A, Gerolymos N, Gazetas G, Tazoh T, Anastasopoulos I (2010) Seismic Behavior of Batter Piles: Elastic Response. *Journal of Geotechnical and Geoenvironmental Engineering*, ASCE, 136, No.9, 1187-1199.
- Priestley MJN, Seible F, Calvi GM (1996) *Seismic design and retrofit of bridges*. Wiley, New York